

Peddinghaus

PeddiBot-1250

ROBOTIC THERMAL PROCESSOR



A Letter from the CEO



Anton Peddinghaus

Welcome to the World of Peddinghaus – The World of “BETTER”.

In the world of Peddinghaus we aim to be better. Take a look at any of our 9,000+ installations throughout the globe. These fabricators experience reduced costs and higher production using our equipment. Why? Because with Peddinghaus they receive better technology, better service and better quality than anyone else can provide. These things aren't easy to do, and not every company can guarantee what Peddinghaus does. I am proud that I can say these things because at Peddinghaus we work harder than anyone to give our customers the best. Whether they are located in New York, Los Angeles, or Chicago; they all receive the very same service, spare parts and support that is second to none.

Welcome to Partnerships – From Software to Service to Sales.

At Peddinghaus we maintain strong partnerships with industry leaders to ensure your success. Whether this is our relationship with leading software providers (such as Shop Data Systems, Sigmanest, Steel Office, Strumis, Tekla, Aveva FabTrol™, Design Data, and more) or our partnership with regional sales and support organizations – our goal is to work together to serve you better.

Welcome to the PeddiBot-1250 Robotic Thermal Processing – The Defining Robotic Machine.

You've asked for it, and now you've got it – Peddinghaus introduces the PeddiBot-1250. This heavy-duty robotic thermal processing line is the first of its kind to feature a triple-torch assembly. No other robotic thermal processor on the market includes rapid torch start capabilities for plasma cutting. Pairing oxy-fuel cutting and layout marking all within one program creates unshakable productivity. This advanced system has rewritten material measurement with a 3D vision scanning system – no probing necessary.

Welcome to Peddinghaus Service – Unmatched Global Support.

At Peddinghaus service is priority number 1. Peddinghaus' global team of customer support representatives are on duty, on call, all the time at our very own 24-hour customer support center. Combined with state-of-the-art remote diagnostic software, readily available local field support professionals, and the industry leading warranty – customer support from Peddinghaus is only a call or a click away.

Welcome to Peddinghaus – A Tradition of Innovation, a Reputation for Excellence.

My great-grandfather and grandfather perfected Ironworkers during their time with Peddinghaus; then it was my father's turn to pioneer the TDK drill line. In today's world I am proud that we at Peddinghaus continue to offer new solutions for our customers such as the PeddiBot-1250. This is only possible through constant innovation and continuing investment in research and development. I invite you to see why Peddinghaus technology is the chosen provider for steel fabricators the world over.

Please visit www.peddinghaus.com for a “video test drive” and additional technical details on the PeddiBot-1250. Or, plan a visit to the Peddinghaus manufacturing campus at our headquarters in Bradley, IL USA. See the depth of our organization, and our commitment to your success with world-class customer support.

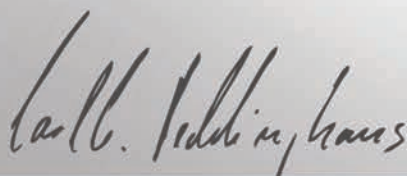
A handwritten signature in black ink that reads "Carl G. Peddinghaus". The signature is written in a cursive style.

Carl G. (Anton) Peddinghaus | Chief Executive Officer | Peddinghaus Corporation

Ideal for Processing Structural Steel in an Array of Applications

Including:

- Agricultural Equipment
- Farm Implement Manufacturing
- Automotive Conveyor
- Assembly Line Fabrication
- Solar Panel Fabrication
- Trailer Manufacturing
- Conveyor Manufacturing
- Earth Moving Equipment Fabrication

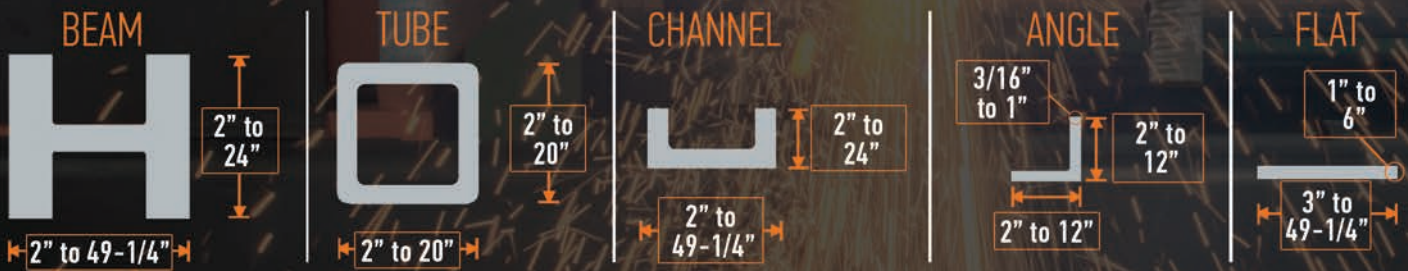

Maximum length of material is 60' and maximum material drive capacities are up to 730 lbs/ft or 43,800 lbs. Minimum length is 43".

Robot Specifications

Maximum Profile Dimensions	24" × 49-1/4"
Minimum Profile Dimensions	2" × 2"
Maximum Profile Thickness	6"
Minimum Profile Thickness	3/16"*
Maximum Profile Weight	43,800 lbs
Robot Arm	6-Axis
Number of Torches	3 (Plasma, Oxy-Fuel, ArcWriting)
Material Processing	4 Sides

Plasma/Oxy-Fuel Specifications

Plasma Torch	HyPerformance HPR 400XD
Max Plasma Edge Start Thickness	3"
Max Plasma Piercing Thickness	2"
Plasma Processing Speed	10"/min @ 3" - 245"/min @ 1/4"
Max Oxy-Fuel Material Thickness	6"
Oxy-Fuel Processing Speed	7"/min @ 6" - 28"/min @ 1/4"
ArcWriting Torch	Hypertherm

* 3/16" for beam, tube, channel and angle



105

105

Bust the Processing Bottleneck

The PeddiBot-1250 is Structural Robotics Done Right

Accelerate processing structural sections with the all new PeddiBot-1250 from Peddinghaus.

Imagine One Machine That Can ...

- Operate burning and ArcWriting functions on top and bottom flange and web
- Utilizes the latest in vision scanning systems - This machine scans 33" of material for maximum accuracy
- Minimize the potential for human error by eliminating manual measurement
- Eliminate the need for constant probing of material
- Minimize the overhead and human error associated with manually laying out and marking weld data onto a profile
- Streamline material handling by minimizing crane lifting of a section to and from a layout station
- Easily integrate into your existing Peddinghaus system due to its modular design



What's the Difference? Old Way vs. New Way

	MANUAL METHODS	PeddiBot-1250
Overall Speed	SLOW	FAST
Slows Other Processes	YES	NO
Accuracy	LOW - Manual	HIGH - Robotic Controlled
Repeatability	LOW - Manual	HIGH - Robotic Controlled
Labor Cost	HIGH - Multiple Employees	LOW - 1 Operator
Material Handling	HIGH - Requires Regular Crane Use	LOW - Roller Handling System
Labor Skill Level	HIGH - Skilled Trade	LOW - Advanced Software Controlled
Footprint	LARGE - Several Fitup Stations	SMALL - 1 Machine and Handling

Do the Work of Five Employees with One PeddiBot-1250

MANUAL PROCESS		PeddiBot-1250	
Cost of 1 Employee/Hour	\$50 per Hour Based on Surveyed Average	Cost of 1 PeddiBot-1250/Hour	\$150 per Hour Based on Surveyed Average
Cost of 1 Employee/Year	\$100,000 per Year Based on \$50/Hour × 2,000 Hrs/Year	Cost of 1 PeddiBot-1250/Year	\$300,000 per Year Based on \$150/Hour × 2,000 Hrs/Year
Cost of 5 Employees/Year	\$500,000 per Year Based on \$100,000 × 5 Workers	Total	\$300,000 Annually

Easily Save \$200,000 Each Year

**Figures are based on an independent study*

High Capacity Processing for Steel

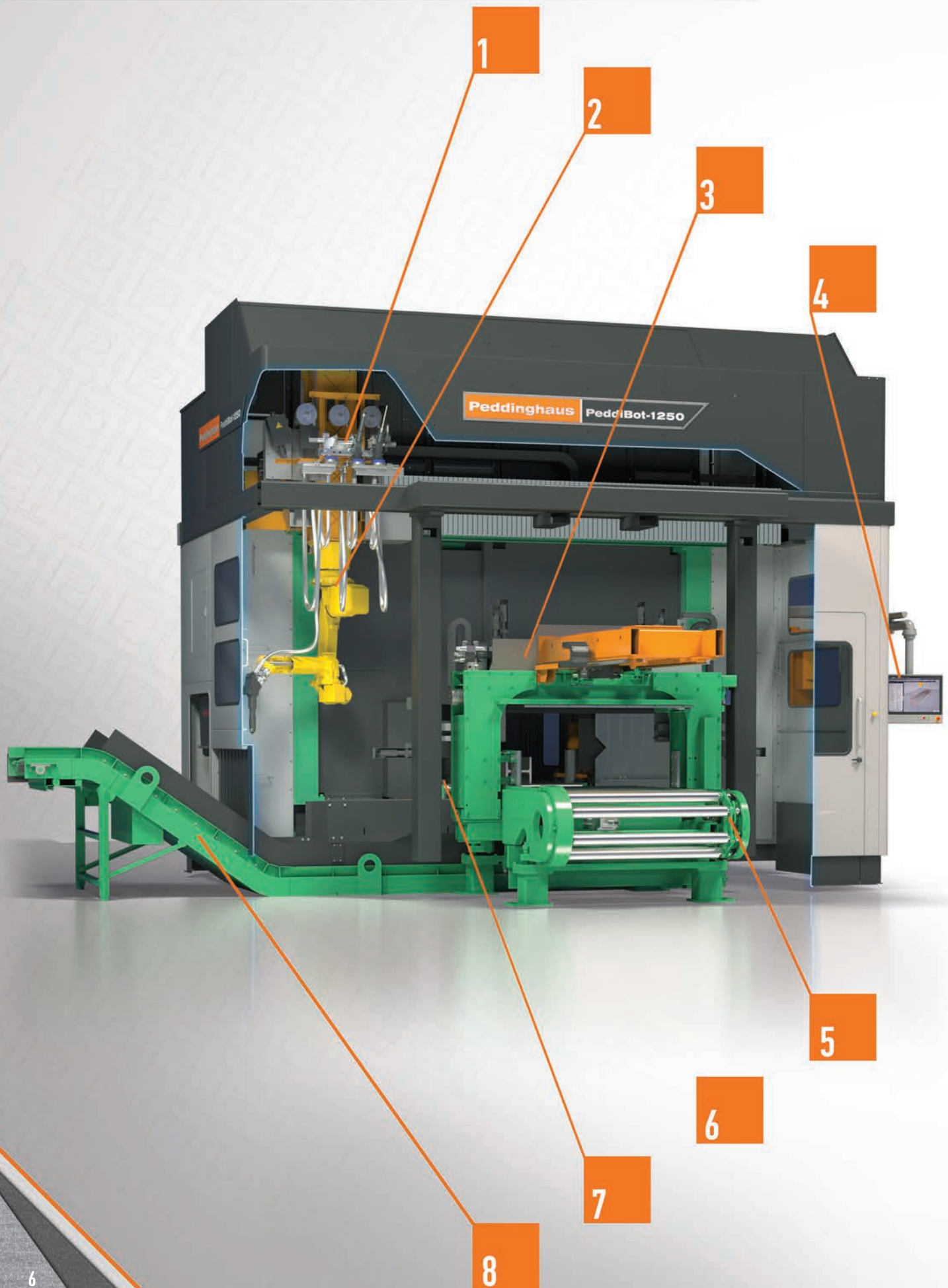



1 PLASMA, OXY-FUEL + ARCWRITING TORCHES

- Hypertherm HPR 400XD plasma torch, oxy-fuel torch and Hypertherm ArcWriting torch heads, conveniently positioned for quick access
- Process copes, flange thins, holes, bevels, layouts and more with ease and efficiency at an accuracy of 1/16" over a 60' profile
- Automated tool changing from plasma to oxy-fuel eliminates unnecessary operator intervention



2 ROBOTIC ARM ASSEMBLY

- 6-axis robot arm suspended from carriage
- Connection coupler allows for fast tool changes
- Collision sensing protects tooling to help keep your production running

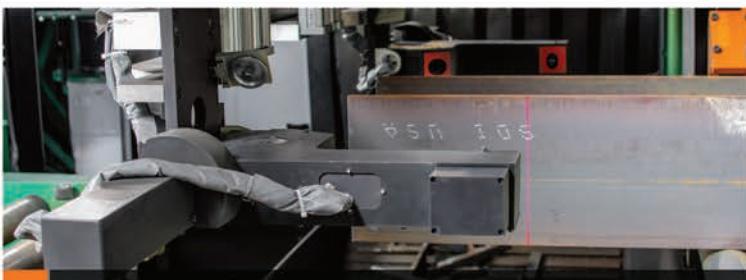

3 PATENTED MATERIAL SCAN + VISION SYSTEM

- Scans 33" of material
- Modern 3D vision software engineering detects true points on incoming material
- Vision gantry allows scanning of material in processing area
- Eliminate the need for continual material probing and streamline productivity



4 ADVANCED CONTROL CONSOLE

- Advanced software operator interface from Peddinghaus
- 21" flat touchscreen
- Modular arm allows for placement of control at any point on the side of machine
- Operator is free to view entire process



5 TELESCOPING MATERIAL SUPPORT CONVEYOR

- Independent from machine frame
- Hydraulically powered conveyor extends rollers to support material leaving outfeed of machine
- The secondary clamp secures the material for the final cut at the end of the raw stock after the remnant handler has handed it off to the clamp



6 PRECISE REMNANT REMOVAL ASSEMBLY

- Positioned on the entry to the machine, it sits above and out of the way of material when entering machine
- Advances remaining remnant material into the process area for final processing
- Advances material onto the telescoping material conveyor

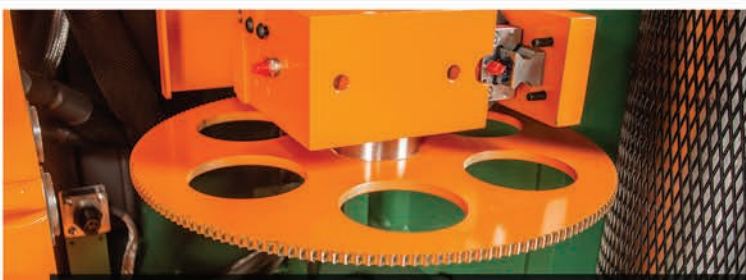

7 ROLLER FEED MEASUREMENT

- The industry standard for Roller Measurement
- Superior accuracy and flexibility on all profiles
- Unparalleled efficiency - load material while machine is in production
- Easily integrate into an existing system with completely modular design



8 HEAVY DUTY SCRAP CONVEYOR

- Easily remove cutoffs and small parts away from the work zone
- Positioned directly under the work area to catch any debris

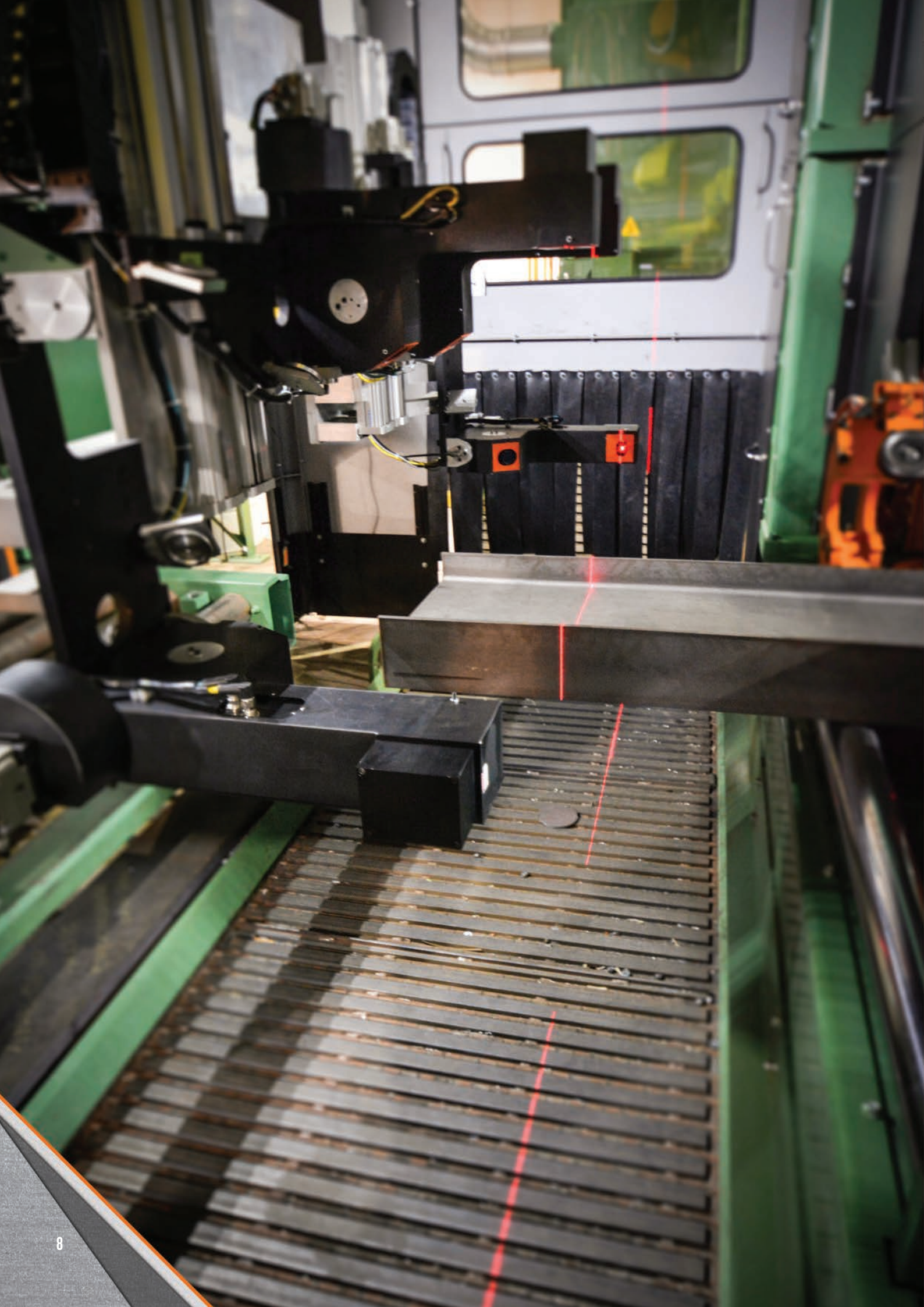

Peddinghaus 3D Vision System

Introducing the Peddinghaus 3D Vision System

The PeddiBot-1250 comes equipped with Peddinghaus' patented 3D vision scanning system. This state-of-the-art configuration creates a precise read of the material being processed without the need for continual probing. Utilizing a telescoping support conveyor, the patented 3D vision system completes a high definition scan within 4.5 seconds. Designed specifically for the structural steel market, this intelligent system is nothing short of robust and handles environments that are common in the industry.

Telescoping Material Support

Material exiting the PeddiBot-1250 is loaded onto a telescoping material support conveyor. This enhanced conveyor system is equipped with rollers that extend to the work area designed to bridge the space between support rollers when processing small or thin material. The conveyor is retracted once the robot is in operation.

Processing More Steel

Material scanning is the future of accurate steel processing. Probing material is far too costly in the competitive fabrication arena. The PeddiBot-1250's vision system remains retracted when not in use leaving the robot with all the room it requires for processing. With more torch-on time, material is processed faster and more accurately.

Advanced Software

The user-friendly software platform processes 3D information from the PeddiBot-1250 directly to the control console. The program is able to produce an accurate display of the material shape, size and thickness by gathering information from the 3D vision system. This intuitive software maps out the required offsets and generates accurate tool paths for production efficiency. Changes to automated tool paths can be made at the operator's discretion prior to processing.

Future Through Technology

The 3D vision system is the future of measuring steel. Peddinghaus continually sets the industry standard for material measurement by keeping production moving without the need to wait on timely probing processes. Reduce shop errors and feed growing production by pairing the PeddiBot-1250's 3D vision system with Peddinghaus' Roller Feed measurement.

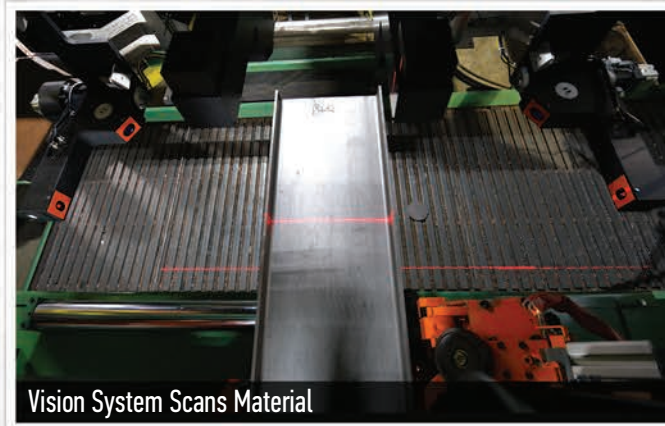



Modular Designs The Peddinghaus Way

Easily Integrate into an Existing Layout

The Peddinghaus Roller Feed material measurement system allows for an array of material handling options. Peddinghaus' conveyors can be quickly expanded, split apart, transferred across from either side (datum or non datum) and modified with no sacrifice in machine accuracy or functionality.

Store Material Handling Outdoors to Minimize Footprint

Peddinghaus' Roller Feed design makes it easy to place material handling outdoors. In addition to saving shop space, this innovative method eliminates unnecessary crane handling that inhibits other operations inside of the shop. Easily unload delivery trucks outside, and load the conveyor without slowing other portions of production.

Your Resource for Shop Flow

Shop layout and material handling efficiency is paramount for cost savings. Every time a profile is handled with a crane, profits are lost. This unnecessary shop cost not only slows the productivity of other processes, but creates unneeded work-related hazards. With the help of Peddinghaus' seasoned layout engineers and systems personnel, fabricators learn the secrets to shop floor success without experiencing the pitfalls of poor layout and planning.

PeddiMatic Intelligent Material Handling

One operator can monitor functions for loading, processing, offloading, trim cut and part removal. This new ultra-modern PeddiMatic system innovation means more production at less cost for every structural fabricator - regardless of shop size.



Minimize Footprint



Modular Configurations



Outside Material Storage



Peddinghaus Software

Linking Design to Fabrication

Overview

The PeddiBot-1250 software is specifically designed to be both versatile and intuitive for many different project environments. The compatibility with DSTV files and Raptor 3D CAD/CAM software along with the advanced control set the standards high for structural steel fabrication.

Raptor 3D CAD/CAM Software Compatibility

The PeddiBot-1250 software is able to receive DSTV files from Raptor after they have been programmed for production. This allows shop programmers to keep production flowing by freeing up the operator from having to generate parts at the control.

DSTV File Handling

The user-friendly software is engineered for today's modern fabricator; this includes allowing operators to import and modify DSTV files. Users can then select which part of the processes they wish to run and the software generates the robotic tool path.

PeddiBot-1250 Control

The modular control for the PeddiBot-1250 allows operators to view the infeed and outfeed processes without leaving the control. The 21" touchscreen monitor displays the software and all monitoring functions. The operators can view and control all functions of the machine as well as complete electronic control of hydraulic and gas pressures.

Programming Parts

Once the material has been scanned, the control will display a real-time 3D model. This model is overlaid on top of existing project information such as copes, scribes, holes and any other processes that are required by the project. From here, the operator can easily monitor and control the production of each piece that is processed.

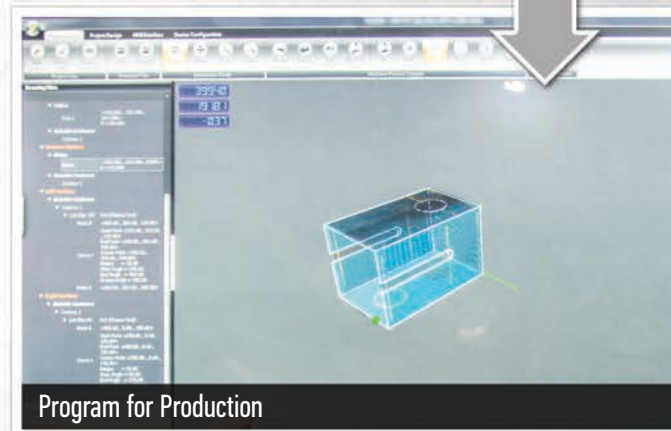
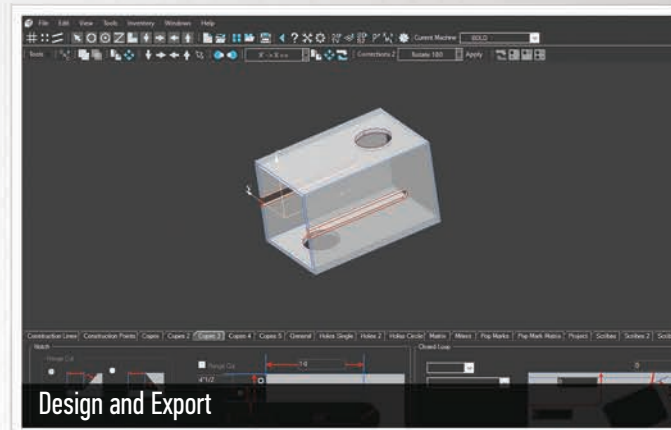



The Best Support in the Industry

Peddinghaus strives to provide an unparalleled level of service for industry partners, no matter where in the world they are located. This is done by offering the only 24-hour technical support center in the industry and employing an expansive team of field service technicians throughout the globe.

24-Hour Technical Support Center

Located in Bradley, Illinois - USA, Peddinghaus maintains a 24-hour technical support center to assist customers with any questions or concerns that may arise in the operation of Peddinghaus machinery. Service technicians leverage remote diagnostic software as well as web cameras in order to troubleshoot questions. Over 95% of telephone calls are resolved without the need for an on-site visit from a Peddinghaus technician.

Global Access to Spare Parts

Peddinghaus maintains vast amounts of spare parts at their North American locations and are in close proximity to major ports and shipping hubs. For international partners, local spare parts storage is maintained at our sales and service offices around the globe. In addition, local dealer representatives and dedicated parts storage facilities have been established throughout the world to expedite part shipments. This means faster delivery of parts when they are needed.

Expansive Team of Field Service Technicians

For advanced issues, over 50 field service technicians are employed by Peddinghaus throughout the world. Technicians are conveniently located geographically and may be based out of an office near your installation. These technicians operate globally and are available for on-site assistance.

World Class Training for Maintenance Staff, Operators and Programmers

Peddinghaus offers training on-site, over the internet and at their corporate headquarters for maintenance staff, operators and programmers. Training at Peddinghaus' global headquarters is free of charge for those willing to make the trip and provides staff with direct access to the masters behind the machinery.

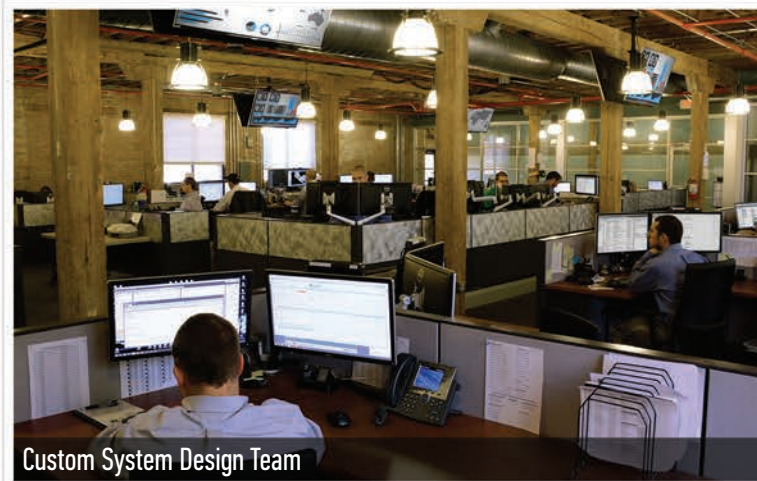

Custom System Design Team



24-Hour Technical Support Center



50+ Field Service Technicians



Peddinghaus

www.peddinghaus.com

Peddinghaus USA • (815) 937-3800 | Peddinghaus UK • +44 1952 200 377 | Peddinghaus Germany • +49 (0) 2332 72-0
Peddinghaus Latin America • +52 81-1001-7087 | Peddinghaus Española • +34 945 465370

PED102720